

solo[®]

416

Operating manual

*Backpack sprayer with
rechargeable battery*

Important!

Read this instruction manual carefully before first operation and strictly observe the safety regulations!

Abbildung → modellabhängig
Illustration → depending on the version
Illustration → selon la version
Imágene → según versión
Figurre → a seconda del modello
Afbbeelding → afhankelijk van de uitvoering



Dear Customer,

We would like to thank you for choosing this quality product from SOLO.

We use state of the art manufacturing techniques and employ comprehensive quality assurance measures to ensure that you are completely satisfied with this modern SOLO device.

We hope that it will provide you with many years of problem-free and successful service.

To ensure that your device will continue to work properly and deliver optimum performance for many years to come, ensure that you follow all instructions in this operating and maintenance manual.

If, once you have read through these operating instructions, anything is unclear or there is anything you would like to ask, please to contact your SOLO dealer or get in touch with our service department directly.

CE Declaration of conformity

SOLO Kleinmotoren GmbH, Stuttgarter Strasse 41, D-71069 Sindelfingen, certifies that the following product in the version as supplied

Description of product: Backpack sprayer with rechargeable battery

Model/type description: **416**

complies with the following EU guide lines: 98/37/EC and RL - 2004 - 108 EC for electromagnetic compatibility.

Applied standards:

ISO 12100 part 1, part 2, DIN EN 294

Serial number, Build year → Type plate

This Declaration of Conformity will become invalid if the product is modified, changed or altered without prior approval.

Sindelfingen,
1st January 2008
SOLO Kleinmotoren GmbH

Wolfgang Emmerich
Managing Director

Symbols / type plate information

The following symbols are used in these operating instructions and on the device itself:

In the operating instructions:



Refer to the operating instructions



Caution



Smoking prohibited



No naked flames



Wear protective gloves

On the device:

Pump toggle switch (12):

- Pump switched on, low operating pressure, approx. 1.4 bar
- Pump switched off
- = Pump switched on, high operating pressure, approx. 2.8 bar



Electrical equipment must not be disposed of as normal domestic waste. Ensure that the device and all electrical accessories are disposed of or recycled at an official disposal or recycling facility for electrical equipment.

On the rechargeable battery (20):



The rechargeable battery contains lead.
The rechargeable battery must not be disposed of as normal domestic waste. Ensure that you take it to an official disposal facility.

Type plate (15):



a: Type designation

b: Serial number

c: Build year (08 → 2008)

	Page
1. Safety regulations	4
1.1 <i>Correct use</i>	4
1.2 <i>General safety instructions</i>	4
1.3 <i>Safe handling of spray pesticides</i>	5
1.4 <i>Safe handling of the rechargeable battery and the charger</i>	5
1.5 <i>Work clothing</i>	6
1.6 <i>Transportation of the device</i>	6
1.7 <i>Before and during work</i>	6
1.8 <i>Maintenance and repairs</i>	6
2. Specification / special accessories	7
3. Standard delivery	8
4. Operating / functional components	8
5. Preparing the unit for use.....	10
5.1 <i>Assembly</i>	10
5.2 <i>Charging the battery</i>	10
5.3 <i>Adjusting the carrying straps</i>	11
5.4 <i>Using the device for the first time ever or after it has been out of use for a long time</i>	11
6. Mixing solutions and filling the solution tank.....	12
7. Using the backpack sprayer.....	13
7.1 <i>Areas of application</i>	13
7.2 <i>Spray nozzle / delivery rates</i>	13
7.3 <i>Spraying</i>	14
7.4 <i>Residual solutions / finishing spraying</i>	14
8. Operating and maintenance instructions.....	15
8.1 <i>General operating and maintenance instructions</i>	15
8.2 <i>Checking the delivery rate of solution</i>	15
8.3 <i>Information on using the rechargeable battery</i>	15
8.4 <i>Replacing the fuse</i>	15
8.5 <i>Draining and cleaning the solution tank</i>	16
8.6 <i>Taking the sprayer out of service and putting it into storage</i>	16
9. Warranty.....	17
10. Wearing parts	17

1. Safety regulations

1.1 Correct use

- This backpack sprayer must only be used for the purpose of applying approved liquid pesticides, insecticides, weed killer (herbicides) and liquid fertilizers available from authorised specialist dealers.
- Observe all instructions provided by the pesticide manufacturer.
- This backpack sprayer must not be used to spray any other media.
- We recommend only using pesticides that have been approved for use by the relevant authorities in your country.
- Never use fluids with a temperature in excess of 40°C.
- The backpack sprayer with rechargeable battery must only be used for the intended purpose described in section 7.1 ("Areas of application") and for the areas of application described there.
- The backpack sprayer must not be used for any other purposes, e.g. for the spraying of liquid paint.

1.2 General safety instructions



Please take the time to carefully read through these operating instructions before using the device for the first time and keep them in a safe place thereafter. Always take great care when using the device.

You can put your life at risk by failing to follow the safety instructions. It is also important to follow any relevant health and safety regulations that apply to your place of work. The operating instructions must be kept available at all times wherever the device is used or stored. They must be read by anyone instructed to use the equipment or perform work with or on the device (including servicing, maintenance and repairs).

- Persons under the age of 18 are only permitted to use this equipment to apply pesticide under supervision, and then only for training purposes.
- Keep persons and animals away from areas in which you are working. Never spray in the direction of other persons, animals or objects that could be damaged as a result. Bear in mind that the liquid emerges at high speed from the nozzle. Objects could be kicked up as a result, and this could in some cases represent a risk. The user is responsible for any hazards or accidents involving other persons and/or their property.
- This equipment must only be hired out, lent or passed on to persons who are familiar with this type of equipment and its operation and who have read the operating instructions. Always ensure that you hand over the operating instructions together with the device.
- Ensure that you are in good shape, well rested and healthy when using this device.
- Never operate the equipment under the influence of alcohol, drugs or medication that could impair your reaction speed.
- Never existing safety equipment or operating controls.
- Never use the device be used if any part of it is unsafe or if it is not in an overall condition that makes it safe to use. Before using the device always check that it is safe to use.
- Only use accessories and add-on parts that have been supplied by the manufacturer and have been specifically approved for installation on the device.
- The quality of any spare parts used is also an important factor in ensuring that your device is reliable and safe to use. Always use genuine replacement parts from the original manufacturer, as these are the only parts that have been manufactured with the same equipment and under the same conditions as the parts originally fitted to the device. This ensures the highest possible level of quality and accuracy of fit – vital factors in ensuring the safety, reliability and proper functioning of your device. Genuine replacement parts and accessories are available from your authorised dealer. Your authorised dealer will also have access to the necessary spare parts lists, from which the required part numbers can be taken, and he will also be kept up to date about any minor improvements and changes to the range of parts on offer. It is also important to note that the use of non-genuine replacement parts will invalidate your warranty.
- When the device is not being used it should be safely stored in a place where it will not endanger the health and safety of others. Switch off the motor and work through the steps in section 8.5 "Draining and cleaning the solution tank" to prepare the device for storage. Ensure that the device is stored in a safe place where unauthorised persons cannot access it.

Anyone who fails to follow the safety instructions, operating instructions or maintenance instructions will make themselves liable for any damage and consequential damage caused as a result.

1.3 Safe handling of spray pesticides

- Pesticides must never be allowed to enter public sewer systems, sprayed onto wastelands, allowed to drain into natural bodies of water or disposed of together with normal domestic waste. This also means that appropriate care must be taken during filling to ensure that none of the pesticide is drawn back into water pipes. Pesticides and any unused leftovers of pesticides must always be collected in a suitable container and disposed of via approved facilities for household chemical waste. Please contact your local authorities for information about your nearest disposal facilities.
- Avoid any direct contact with pesticides.
- Stop working immediately if you start to feel unwell while working, or if you become unusually tired. Seek medical advice if the condition persists.
- Never allow children or anybody who is not familiar with handling this type of spraying agent to handle the spraying agent.
- Clean the solution tank whenever the spraying agent is changed. Run the backpack sprayer with clear water after cleaning the solution tank – but before the next spraying agent is filled – flush out any residue from the pump and the hoses. This will prevent the risk of any chemical reactions taking place between the different substances.
- Never spray in narrow or enclosed spaces – pesticides are toxic and there is a risk of poisoning. Spraying equipment must for example only be used in greenhouses if adequate ventilation is provided. Signs must be put up in greenhouses that have been treated. Nobody should enter the greenhouse again until it has been thoroughly ventilated.
- When you have finished spraying, follow the steps in section 8.5 "Draining and cleaning the solution tank" to prepare the device for storage, thoroughly wash your face and hands with soap, take off your work clothing and ensure that it is washed regularly.
Any unused pesticide that is left over in the device could cause corrosion and hence damage the device. Special attention must be paid to wearing parts like nozzles, filters and seals.

1.4 Safe handling of the rechargeable battery and the charger

- The charger must only be connected to a mains supply with an operating voltage between 100V and 240V AC 50/60Hz. It must only be connected using the correct power cable with a EURO plug and, if required, one of the supplied adapter plugs.
 - Check that the mains voltage is correct before connecting the device.
 - Use the correct mains adapter plug.
 - The charger must not be connected to the mains supply in countries for which no matching mains adapter plug is supplied together with the backpack sprayer or in countries where the mains voltage differs from the operating voltage of the charger. In this case you should contact a local dealer to enquire about options for connecting the charger to the mains supply.
- Always hold the body of the plug when plugging it in and disconnecting it. Never pull it out by the cable.
- The charger is only designed to recharge the rechargeable battery that is supplied by SOLO for this backpack sprayer. Ensure that the battery is always correctly connected to the charger before charging.
- Never connect the two terminals of the rechargeable battery (+ / -) with a conducting object (short circuit).
- Keep the charger, the rechargeable battery and all of the electronics well away from splash water. These areas should only be cleaned with a dry or slightly damp cloth. Before cleaning, always disconnect the power plug from the socket and the charging cable from the charging socket on the device.
- The rechargeable battery contains dangerous substances. Never open the battery or the charger.
- Only use the original charger to recharge the battery.
- The rechargeable battery and the charger must not be disposed of as normal domestic waste. Ensure that you take them to an official disposal facility for electrical equipment.

1.5 Work clothing



Always wear suitable protective clothing in accordance with the relevant regulations. The clothing must protect all parts of your body against contact with pesticides and against objects that are kicked up – i.e. protective gloves, face protection (e.g. protective goggles), protective footwear, body protection – e.g. rubber apron, possible breathing protection.

- Clothing should be appropriate – i.e. tight-fitting, but not obstructive.
- Never wear a scarf, tie, loose jewellery or other items of clothing that could be caught in a bush or on a branch.
- Always wear a breathing mask when working in dense and tall plants, in well-ventilated greenhouses and when using spraying agents that are dangerous.
- Immediately change any clothing that becomes soaked with the spraying agent.

1.6 Transportation of the device

- Always switch off the pump when transporting the device.
- To prevent damage and to eliminate potential hazards for other road users, use secure lashing equipment to secure the device and prevent it from tipping over and falling when transporting it on a vehicle.
- Take appropriate measures to ensure that the spraying agent cannot leak or spill. Check the solution tank, the pump, the fuel tank and all hoses and pipes that carry the spraying agent for leaks. Before transporting the device you should ideally work through the steps in section 8.5 "Draining and cleaning the solution tank" to prepare the device for transportation.

1.7 Before and during work

Every time before you start using the device, check the entire device to ensure it is safe to use.

- The toggle switch on the pump must function properly.
- Check the solution tank, the pump and all hoses and pipes that carry the spraying agent for leaks.
- Never start working if there are any irregularities, if you can see any damage to the equipment (including the support frame), if any of the adjustment settings are incorrect or if the equipment is not working properly in any way. In this event, have your device checked by a specialist workshop.
- The device must only be operated by one person at a time. Nobody else must be within a radius of 5 metres at the same time.
- When switching the pump on, ensure that the hand valve on the spray tube is not set to continuous spraying mode. The hand valve must be closed. Point the spray tube towards a free area.
- Always ensure that there is an adequate air change when working in restricted conditions, in tight, tall plant growth, in well-ventilated greenhouses, in dips in the ground or in trenches.
- Always remain within calling distance of other persons who could help in the event of an emergency.
- Take breaks at regular intervals.



Never smoke in areas where you are working.

1.8 Maintenance and repairs

Only perform maintenance work and repairs yourself if they are covered in these operating instructions. All other work must be carried out by an authorised workshop.

- The device must not be serviced, repaired or kept in the vicinity of naked flames.
- Before cleaning, servicing or repairing the device always switch off the pump and unplug the charger from the charging socket of the device.
- The high-pressure hose (7), hand valve (8), pressure gauge (9) (depending on the version), spray tube (10) and the nozzle attachment (11) must only be unscrewed if the pump is switched off and the device is depressurised. To do this, with the pump switched off, hold the spray tube in the solution tank or in a suitable container for the spraying agent and operate the hand valve.
- All repairs must only be performed using genuine replacement parts from the manufacturer.
- The device must not be altered in any way, as this could adversely affect the safety of the device and potentially cause an accident or injury.

2. Specification / special accessories

Solution container, nominal volume	I		20
Filling strainer mesh aperture	mm		0.55
Residual volume not properly discharged by the device	ml		< 50
Operating pressure with standard nozzle	Setting I	bar	Approx. 1.4
	Setting II	bar	Approx. 2.8
Delivery rates for the spraying agent, standard nozzle	Setting I	l/min	0,44
	Setting II	l/min	0,56
Spray tube	Material		PVC
	Length	mm	500
Spray hose	Length	mm	1500
Standard spray nozzle			Flat jet nozzle (green) F 015-80
Accessories Nozzle-kit	Part no.		4074504
	Part no.		4900448
Mesh aperture, ball valve filter	mm		0.35
	Part no.		4900539
Pump			Electric pump, 12 V
Rechargeable battery			Lead gel rechargeable battery
Rated voltage	V		12
Capacity	Ah		5
Charger	Input operating voltage	V	100-240
	Frequency of operating voltage	Hz	AC 50/60
	Rated output voltage	V	DC 12
	Max. charging current	A	1
Charging time with minimum initial battery charge			
	Standard battery 5 Ah	h	Approx. 5
	Upgrade battery 7.2 Ah	h	Approx. 7
Fuse			Glass fuse, 5x20 mm, 4A SOLO part no.: 00 84 055
Possible operating time per charging cycle			
	With standard battery 5 Ah	Setting I Setting II	h h
Charger, protection type/protection class			IP 20 / II
Weight (ready for operation, tank empty)	kg		6.4
Dimensions without spray tube and spray hose	mm		Height: 670 / Width: 380 / Depth: 250
In determining the following values regarding the acceleration of vibrations and sound, the different operating conditions were weighted in accordance with the current standards			
Sound pressure level L_{peq} (EN ISO 3744)	dB(A)		< 70
Sound power level L_{Weq} (EN ISO 3744)	dB(A)		< 70
Weighted effective acceleration $a_{hv,eq}$ (EN ISO 5349)	m/s^2		< 2.0
Upgrade: Rechargeable battery 12 V 7.2 Ah	Part no.		0084110
Charging cable for external charging	Part no.		5900789

3. Standard delivery

- Standard device with hand valve pre-assembled on the high-pressure hose
- Spray tube with pre-assembled nozzle attachment
- Charger with mains cable / EURO plug and 3 mains plug adapters for different countries
- 1x sticker for the solution container for each of the following: Herbicide, Fungicide and Insecticide.
- These operating instructions

4. Operating / functional components

View: left hand side

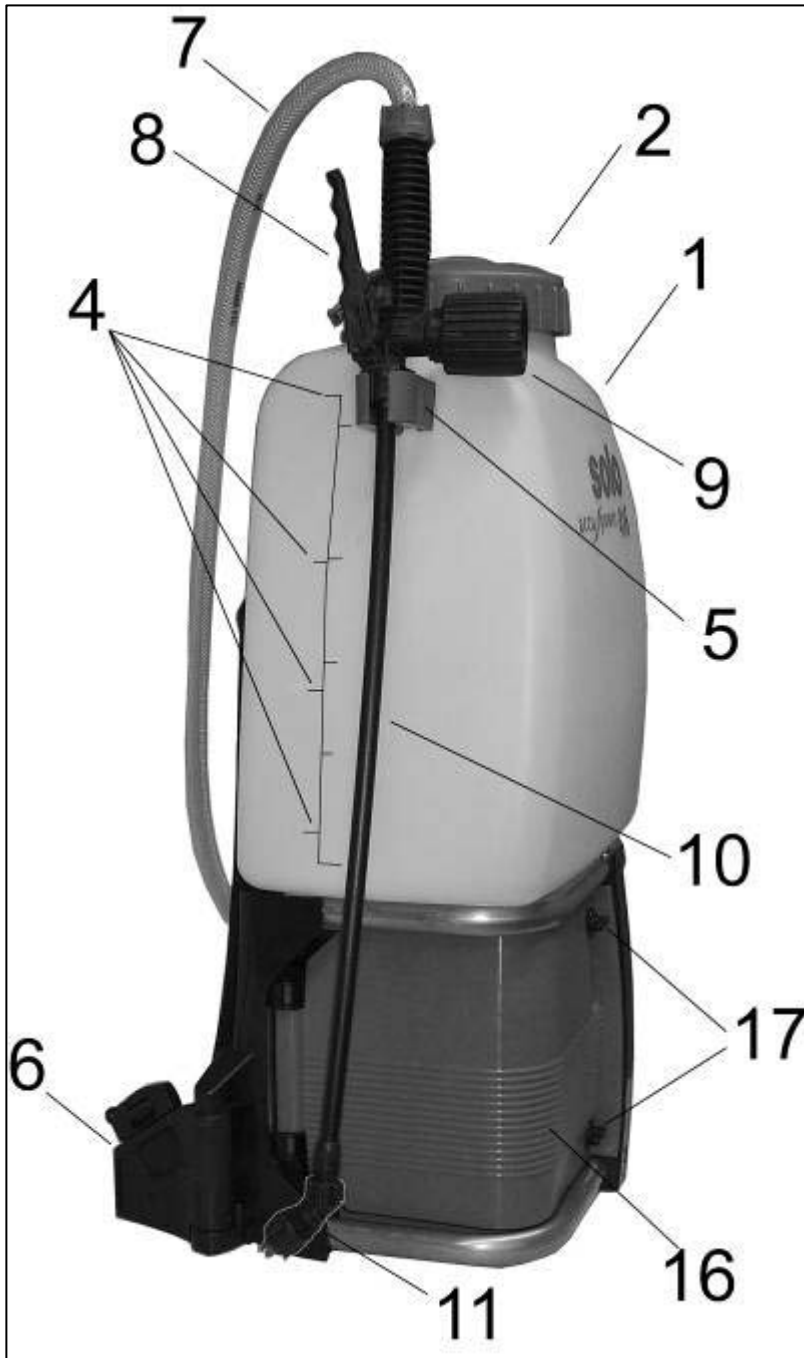

1. Solution tank
2. Screw cap
3. Filling strainer
4. Fill level markings
5. Spray tube holder
6. Strap holder with clip (carrying straps)
7. High-pressure hose
8. Hand valve
9. Pressure gauge (depending on the version)
10. Spray tube
11. Nozzle attachment
12. Pump toggle switch
13. Charging socket
14. Fuse holder
15. Type plate
16. Protective casing
17. Locking buttons
18. Drain valve
19. Drain hose, attached to the rear panel
20. Rechargeable battery
21. Charger
22. Power cable with EURO plug
23. Mains plug adapter

View: top, solution tank opened

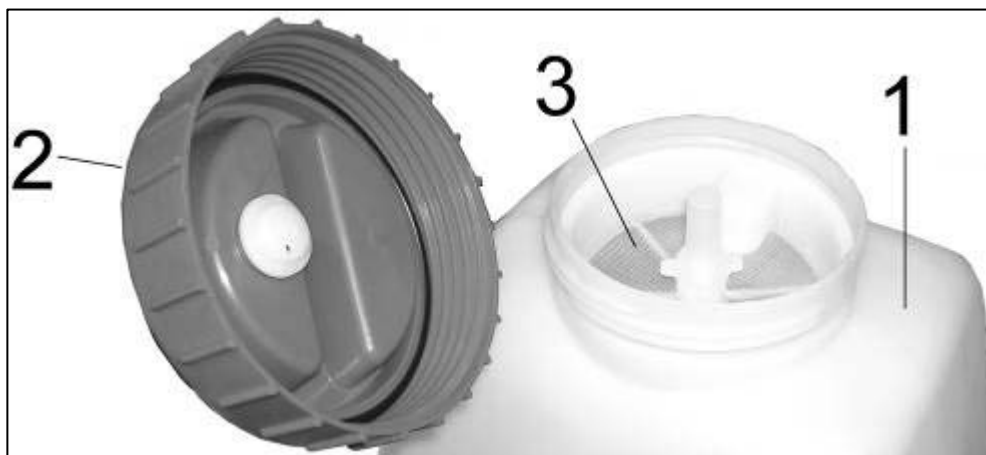

View: right hand side, lower part



View: protective housing opened

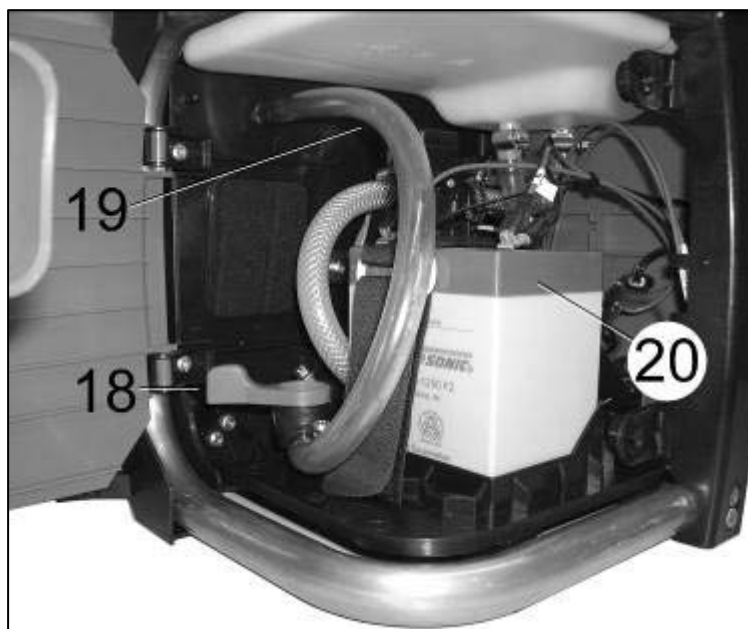

Charger and mains outlet adapter

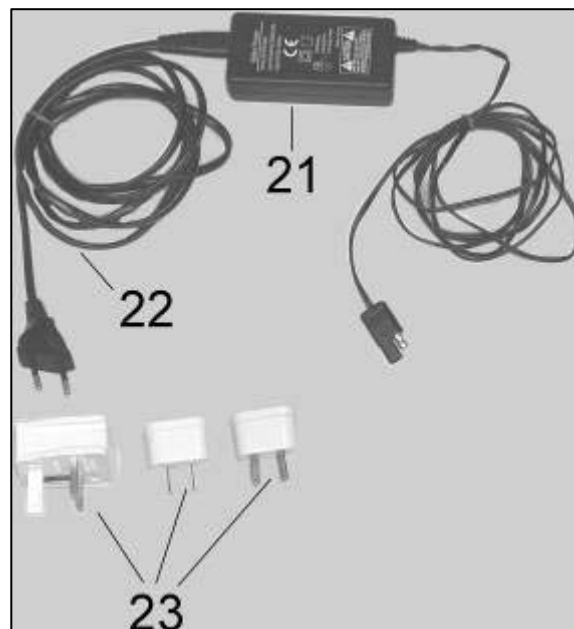

5. Preparing the unit for use

5.1 Assembly

The backpack sprayer with rechargeable battery is dismantled before it is dispatched. It must be fully reassembled again before it is used.

Connecting the battery

Ensure that the pump toggle switch (12) is set to "0" (pump is switched off).



Rotate the two locking buttons (17) approximately 100° anti-clockwise to release the protective casing.

→ Open the protective casing.

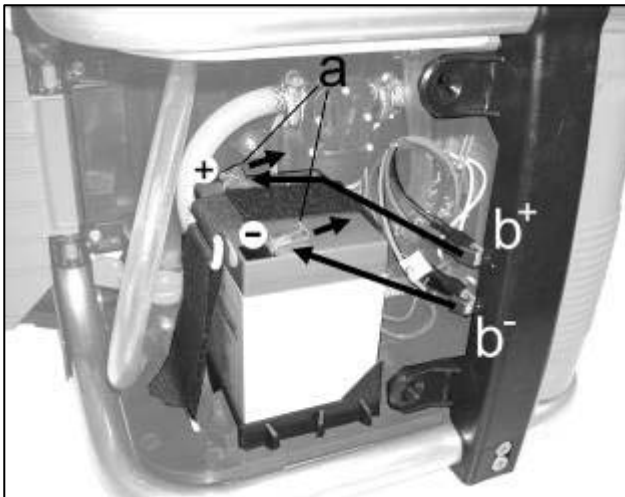

- Pull off the lengths of protective tubing (a) from the battery terminals..
- Pull each double plug (b⁺, b⁻) right off the bridge on the protective casing and connect them to the **correct terminal** on the rechargeable battery.

Positive terminal: connect the red cable to the red terminal on the rechargeable battery.

Negative terminal: connect the blue cable to the black terminal on the rechargeable battery.

Check that the double plugs are securely connected and that polarity is correct.

Close the protective casing and twist the locking buttons back in a clockwise direction until they are horizontal.

Assembly of the spray tube

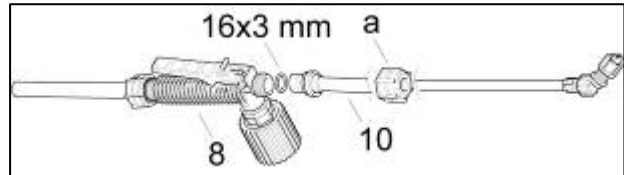

The O-ring (16x3 mm) is used to provide a seal between the spray tube (10) and the hand valve (8).

Manually tighten the union nut (a) on the hand valve.

(Pressure gauge depending on the version)

5.2 Charging the battery

Read the safety instructions.

The rechargeable battery needs to be charged before you can use the backpack sprayer for the first time.

The standard battery (5 Ah) needs to be charged for at least 5 hours, while the optional upgrade battery (7.2 Ah) needs to be charged for at least 7 hours.

Before charging, connect the battery as described in the previous section.

Connect the charging cable of the charger to the charging socket (13) of the backpack sprayer.

Connect the charger to a suitable power supply using the supplied power cable and EURO plug. Use one of the supplied adapter plugs if the supplied EURO plug does not fit in your mains outlet.

The charger automatically adapts to any AC 50/60 Hz mains voltage between 100 V and 240 V.

While the battery is charging, the LED on the charger lights up red. Once the battery is fully charged, the LED switches to green and charging stops automatically. Over-charging of the battery is prevented.

Once the charging process is finished, disconnect the power plug from the socket and then disconnect the charging cable from the charging socket on the backpack sprayer.

5.3 Adjusting the carrying straps

Clip the carrying straps into the clips (6) on both sides and lift the backpack across your shoulders.

Use the sliding clips, adjust the shoulder straps to the right length.

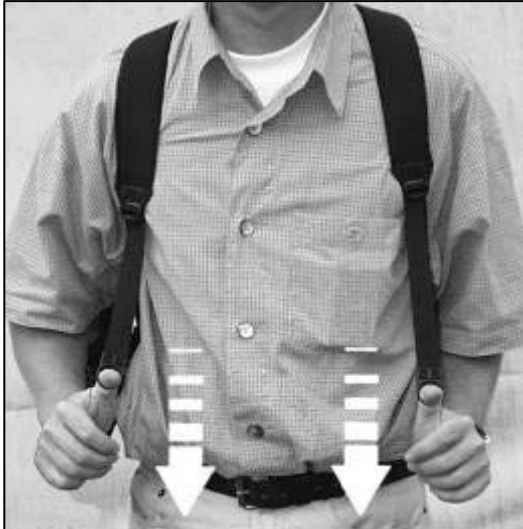

Pull the loose ends of the carrying straps to tighten them.

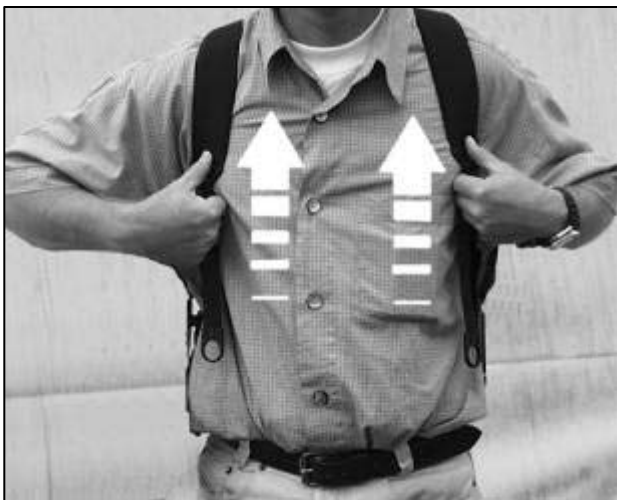

Lift up the two sliding clips again to release the straps.

When adjusting the straps, ensure that the back panel fits snugly and securely against the back of the person wearing the backpack.



Fit the bottom strap around the midriff of the wearer and close the clip, again using the sliding clips to adjust the length of the straps as required.

5.4 Using the device for the first time ever or after it has been out of use for a long time

Before using the backpack sprayer for the first time with pesticide, or if it has not been used with pesticide for a long period of time, first perform a trial run of the equipment with water to check that everything is working properly and that there are no leaks.

Ensure that you follow all safety instructions – even during the trial run.

Trial run:

After performing a visual inspection of the device, fill the solution tank with approximately 5 litres of water – the drain valve (18) must be closed (the lever should be set at right angles to the hose).

Check all components for leaks.

Check the following components to ensure that they work properly: pump toggle switch (12), hand lever (8), pressure gauge (9) (depending on the version).

Tip: During the trial run, try spraying some water with both pressure settings to get a feel for using the backpack sprayer.

Never start working if there are any irregularities, if you can see any damage to the equipment (including the support frame) or if the equipment is not working properly in any way. In this event, have your device checked by a specialist workshop.

6. Mixing solutions and filling the solution tank

! When handling the substances for spraying, always follow the safety instructions printed at the start of these operating instructions (pay special attention to section 1.3 "Safe handling of spray pesticides") and the information provided by the manufacturer of the particular substance being sprayed.

Additional general rules for filling the solution tank

! Always ensure that the drain valve (18) is closed before filling any fluids into the solution tank (the lever should be set at right angles to the hose).

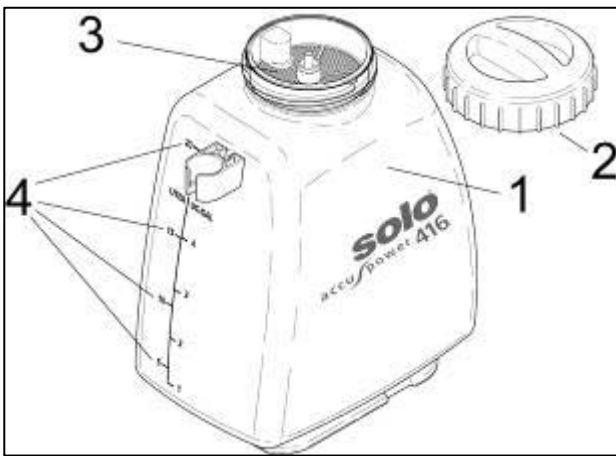

Markings (4) are applied to the side of the solution tank (1) to indicate the fill level. The solution tank has a maximum capacity of 20 litres (top marking). When filling up with correctly mixed spraying agent, ensure you do not fill above the top marking.

The filling strainer (3) in the spraying agent filler opening has a mesh aperture of 0.55 mm. Always use the filling strainer when filling the solution tank. Check the filling strainer before filling the tank. If the strainer is damaged, replace it with a genuine replacement part (part no.: 4200104) with the correct mesh aperture.

When you are filling the tank with spraying agent, switch the pump off, take the device off your back and place it on a suitable surface. Never allow the solution tank to overflow or public bodies of water, rainwater drains or sewage drains to become contaminated. Wipe up any spilled solution immediately.

When filling the tank, always ensure that the hand valve and the drain valve are closed.

Never mix the spraying agent directly in the solution tank.

After filling, firmly close the screw cap on the filling opening to prevent any solution from escaping.

Required volumes of spraying solution

Mix the solutions in accordance with the instructions provided by the manufacturer of the spraying agent. Choose the appropriate volume according to requirements.

The following are guide values for plant protection:

- Plants cultivated at ground level – 0.3-0.5 l per 10 m²
- Low shrubs – 1.0-1.5 l per 10 m²
- Espalier trees, bush trees 0.5-1.0 l per tree
- Larger bush trees 2.0 l per tree

Mixing pesticides

Only mix pesticides out in the open. Never do this inside living spaces, stables or in storage spaces that are used for food or animal feed.

Pesticides in powder form:

- Mix the pesticide in a separate container, not in the solution tank.
- Ensure that the mixture is thoroughly mixed before pouring it through the filling strainer into the solution tank.
- Use the spray tube to mix the spraying solution in the tank again.

Liquid pesticides:

- Fill 1/4 of the solution tank with water.
- Then pre-mix the spraying agent with water in a separate container according to the instructions provided by the manufacturer of the spraying agent.
- Pour the pre-mixed solution through the filling strainer into the solution tank.
- Top up with the required amount of water in accordance with the manufacturer's instructions.
- Use the spray tube to mix the spraying solution in the tank again.

When using spraying agents that have been mixed from herbal preparations, the liquid will need to be pre-filtered before pouring it through the filling strainer, as otherwise the strainer may become blocked.

Identification of the tank contents

Attach the relevant sticker to indicate the contents of the tank (i.e. Herbicide, Fungicide or Insecticide).

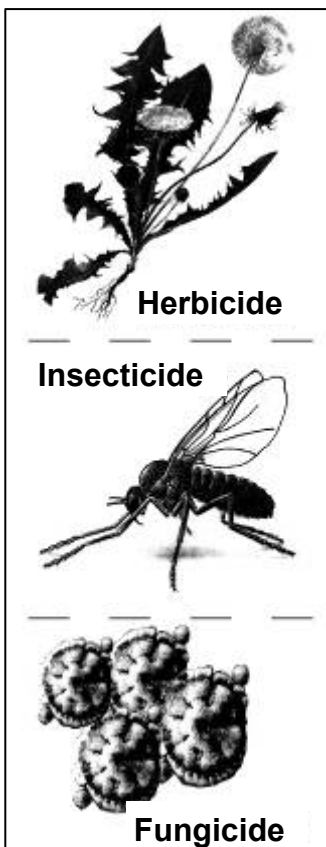

CAUTION:

Never fill different spraying agents into the solution tank without first thoroughly cleaning the solution tank and all parts that come into contact with the spraying agent and flushing the system with plenty of water. We recommend the use of the special SOLO cleaner for pesticide sprayers that is available in 500 ml bottles. Part no.: 4900600

7. Using the backpack sprayer

7.1 Areas of application

This backpack sprayer is suitable for the purpose of applying approved liquid pesticides, insecticides, weed killer (herbicides) and liquid fertilizers available from authorised specialist dealers. We recommend using only pesticides that have been approved for use by the relevant authorities in your country.

The backpack sprayer can be used for applications in agriculture, tree nurseries, forestry, fruit growing, vineyards, vegetable growing and greenhouse cultivation (provide adequate ventilation).

7.2 Spray nozzle / delivery rates

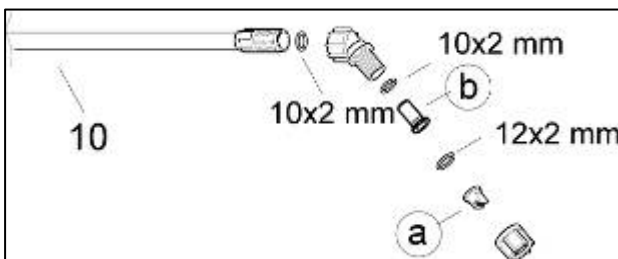

A flat jet nozzle (green) F 015-80 (a) is pre-assembled as the standard nozzle.

The following delivery rates apply to this nozzle when it is used in conjunction with this particular backpack sprayer:

Pump toggle switch	Delivery rates in l/min
Setting I	0,44
Setting II	0,56

A ball valve filter (b) is fitted in the elbow piece upstream of the spray nozzle, which minimises any dripping from the nozzle when the hand valve is closed. The mesh aperture of the filter is 0.35 mm. If you need to replace the filter, ensure that you only fit an original filter with the part no. 4900539 with the same mesh size.

ENG

7.3 Spraying

Ensure that you follow all of the safety instructions when using the backpack sprayer.

Never use the sprayer under windy conditions or if it is raining, as this would risk widespread drifting of the spraying agent.

Check the wind direction before starting work.

It is best to perform spraying work in the morning or evening, as it tends to be less windy then.

- Carry the properly adjusted and prepared device on your back.
- Hold the spray tube at the hand valve.
- Leave the hand valve closed when you switch on the pump (i.e. do not pull the lever).
- Select the required operating pressure at the pump toggle switch according to the required range and delivery rate.
In setting II the pump automatically switches off when the operating pressure is reached at the hand valve. If the pressure drops while spraying then the pump will automatically switch back on again. This arrangement ensures that the full capacity of the rechargeable battery is used in the best possible way.
In setting I, the switch-off pressure may not always be attained even if the hand valve is closed, and the pump will then run continuously as a result. In this case we recommend switching the pump off manually via the toggle switch during breaks in spraying.
Always completely switch off the pump via the toggle switch before extended breaks or at the end of spraying.

- Pull the hand valve lever (a) to spray.

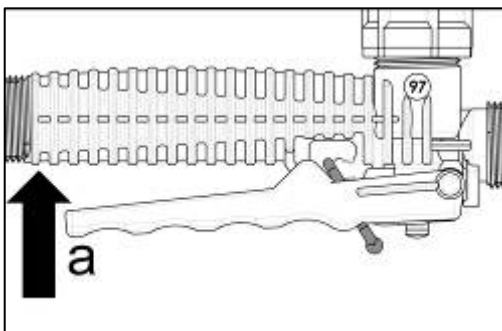

The red clip can be used to secure the hand valve in its rest position to prevent accidental spraying.

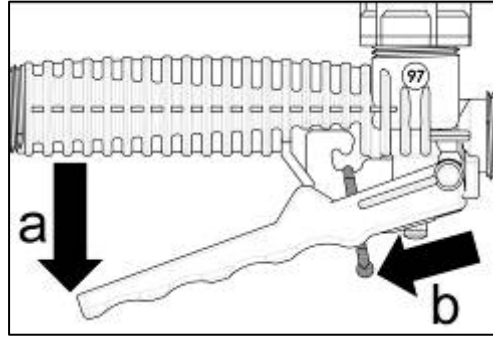

For this, pull the lever slightly away from the handle (a) and lock the clip (b).

Never spray towards open windows or doors, cars, animals, children or anything else that could be damaged by the chemicals being sprayed.

Always proceed with the greatest of care when spraying.

Ensure that you only cover the intended areas.

If the operating pressure built by the pump drops noticeably and the pump fails to get the pressure back up to the normal operating level, stop spraying with the current battery and recharge the battery.

7.4 Residual solutions / finishing spraying

Switch off the pump immediately when any air is sucked in and sprayed out through the nozzle. This is indicated by a mist being sprayed from the nozzle. At this point the solution tank will still contain a residual amount of less than 50 ml. If you do not want to add more spraying agent and wish to stop spraying instead, dilute this leftover amount with one litre of water and spray it on the treated area. After switching off the pump, hold the spray tube facing down towards the treated area and operate the hand valve to discharge any residual quantities of spraying agent left in the high-pressure hose.

Never allow the pump to run with an empty solution tank. Running the pump dry will result in pump damage.

Switch the pump off when you finish working with the sprayer. Follow the steps in section 8.5 "Draining and cleaning the solution tank" to prepare the device for storage, thoroughly wash your face and hands with soap, take off your work clothing and ensure that it is washed regularly.

8. Operating and maintenance instructions

8.1 General operating and maintenance instructions

After running in the device for approximately 5 operating hours, check all accessible nuts, screws and bolts to ensure that they have not become loose. Retighten them as required.

Every time you use the backpack sprayer, first check it all over to ensure it is safe to use.

8.2 Checking the delivery rate of solution

At least once at the start of every spraying season, check whether the delivery rate of the sprayer (measured in litres per minute) still corresponds to the value indicated in section 7.2 "Spray nozzle / delivery rates".

For this, fill up the tank to the maximum marking, start it up and spray for exactly one minute.

Then measure the quantity of water required to refill the tank to its maximum level.

The value measured corresponds to the amount of water delivered by the device in l/min for the selected operating pressure. This value must not deviate by more than 10 % from the value indicated in section "7.2 Spray nozzle / delivery rates".

If the actual value is too low, this may be caused by deposits in the nozzle. Clean the nozzle and repeat the test.

If the actual value is too high, this may be due to wear or damage to the spray nozzle.

When checking the solution delivery rate of the device, also check whether the nozzle is producing an even, fan-shaped spray pattern.

8.3 Information on using the rechargeable battery

When used properly, the rechargeable battery will remain in good working order for many years. It is important to note that the rechargeable battery should never be fully discharged.

If the operating pressure built by the pump while spraying drops noticeably and the pump fails to get the pressure back up to the normal operating level, stop spraying with the current battery and recharge the battery.

If the backpack sprayer with rechargeable battery is not used for an extended period of time then we recommend recharging the battery once a month with the supplied charger. This will prevent the battery from deep-discharging.

Alternating between two batteries

We recommend purchasing a second rechargeable battery if you need to be able to keep working indefinitely without having to stop when the battery is dead. Also remember to order the SOLO charging cable, part no.: 5900789. This second charging cable will allow you to recharge the second battery independently of the backpack sprayer.

When alternating between two batteries you can use one of the rechargeable batteries to run the sprayer while the second rechargeable battery is recharged by the charger via the separate charging cable. The batteries are easy to swap – simply open the protective casing and undo the Velcro strap. Ensure that the polarity is correct when the cables are connected to the rechargeable battery (see section 5.1) and that the battery is firmly secured with the Velcro strap.

8.4 Replacing the fuse

Replacement glass fuses (5x20 mm 4A) are available to order from your local SOLO dealer under the part no. 0084055.

To replace the fuse, release the fuse holder (14) with a screwdriver (turn it half a turn anti-clockwise) and then pull it out.

After inserting a new fuse, slide the fuse holder back in and lock it by twisting it half a turn clockwise.

If the fuse blows repeatedly have the device checked by a specialist workshop before returning it into use.

8.5 Draining and cleaning the solution tank

Draining the solution tank

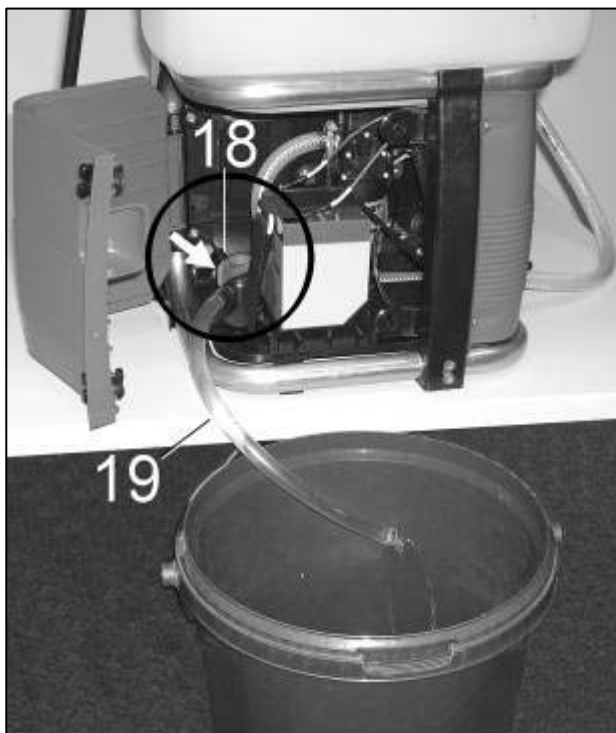

- Place the backpack sprayer level on a horizontal surface.
- Rotate the two locking buttons (17) approximately 100° anti-clockwise to release the protective casing.
→ Open the protective casing.
- Hold the end of the discharge hose (19) into a suitable container.
- Open the drain valve (18) (the lever should be set parallel to the hose).
- After draining: Close the drain valve (the lever should be set at right angles to the hose) and reattach the discharge hose to the rear panel.
- Close the protective casing and twist the locking buttons back in a clockwise direction until they are horizontal.

Drain the solution tank daily after use and thoroughly flush it with water. Please read and observe the cleaning instructions in the instructions for use supplied with the pesticide. We recommend the use of the special SOLO cleaner for pesticide sprayers that is available in 500 ml dosing bottles. Part no.: 4900600

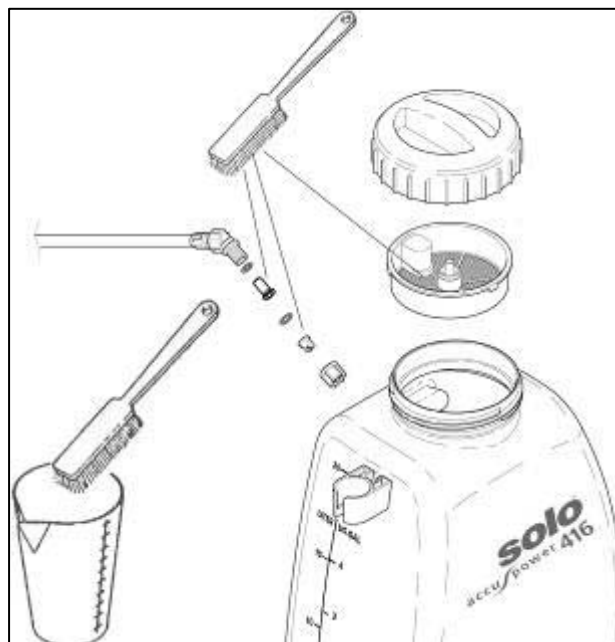

Clean the filling strainer, the ball valve filter at the spraying nozzle and the spraying nozzle periodically with water using a soft brush. Do not use your mouth to blow through the spray nozzle!

After cleaning, leave the solution tank open to dry.

8.6 Taking the sprayer out of service and putting it into storage

Work through the steps in section 8.5 "Draining and cleaning the solution tank" to prepare the device for storage.

Store the device in a secure, dry and frost-free location under a maximum ambient temperature of 35°C.

There must not be any open fires or similar nearby.

Even when the unit is not in use, regularly recharge the battery (and the spare battery if you have one) once a month with the supplied charger.

Ensure that the unit cannot be used by unauthorised persons, in particular children.

9. Warranty

The manufacturer guarantees problem free quality and will cover the cost of replacing parts which are found to be faulty in material or show manufacturing defects within the prescribed guarantee period after the date of purchase. Please note that specific guarantee conditions may differ from country to country. When in doubt, please ask the vendor of the goods. The vendor of the product is responsible for guarantee applications. We hope you will understand that we cannot be liable for damage resulting from these causes:

- Non-compliance with operating instructions.
- Neglecting required maintenance and repair jobs.
- Wear from normal use.
- Using non-approved tools.
- Use of force, improper treatment, misuse and accidents.
- Attempted adjustments and repairs by non-qualified persons.
- Use of unsuitable spare parts or non-original parts if such parts are the cause of the damage.
- Use of non-approved media in the solution tank.
- Damage caused by using the product in the hire or rental industry.

Normal cleaning, adjustments or maintenance jobs cannot be claimed as part of the guarantee.

All guarantee work must be carried out by a service centre authorized by the manufacturer.

10. Wearing parts

Various parts are subject to application-specific wear or to normal wear and must be replaced in good time if necessary. The following parts are subject to normal wear and are not covered by the manufacturers guarantee:

- All rubber parts that come into contact with the spraying agent
- Spray nozzle
- Filters
- Seals
- Rechargeable battery
- Fuse

In the best interest of continued technological progress we reserve the right to change the design and configuration of any product without prior notice.

For that reason, no claims can be accepted with reference to text and illustrations in this manual.

solo[®]

Made in Germany

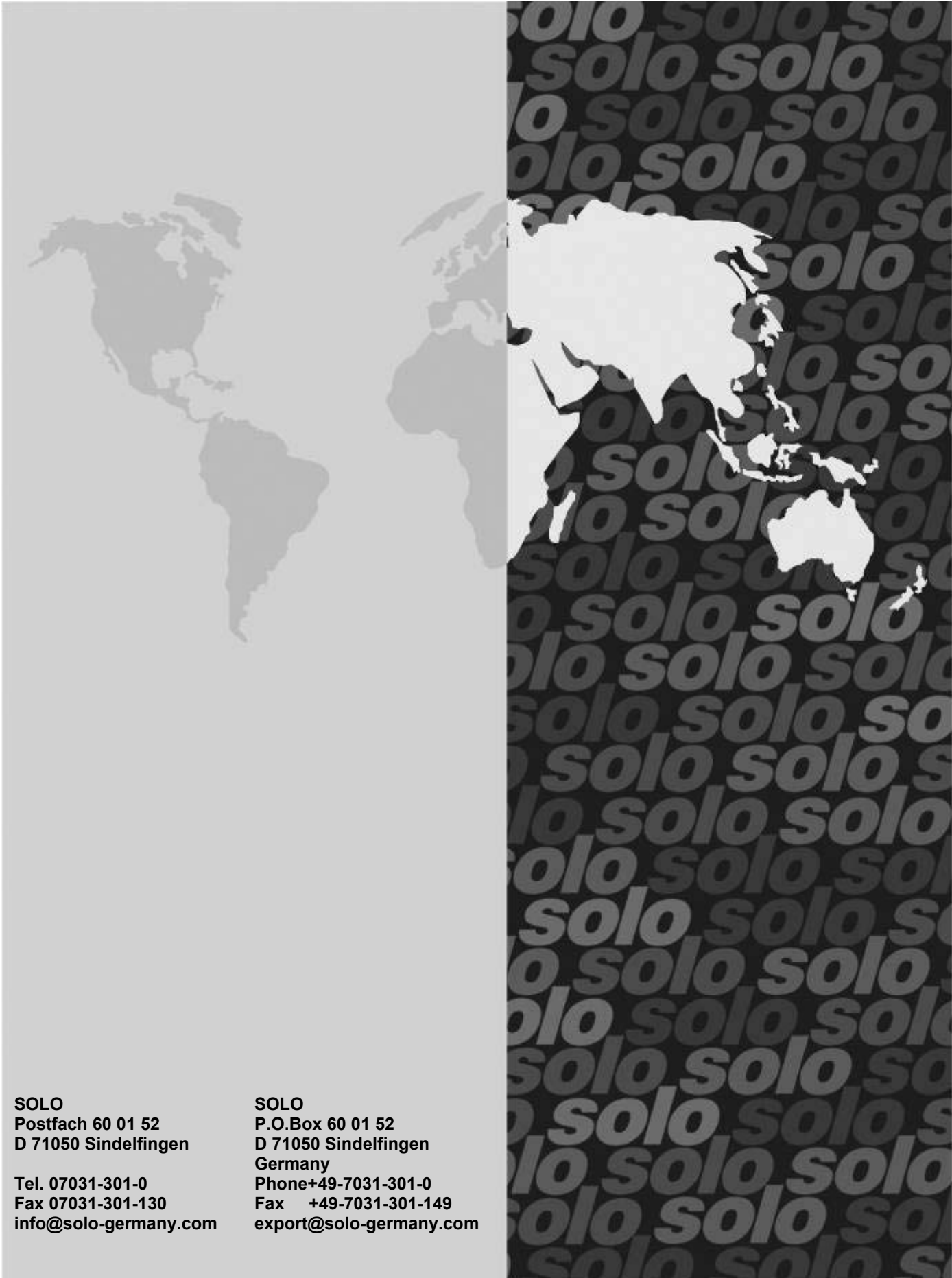

SOLO
Postfach 60 01 52
D 71050 Sindelfingen

Tel. 07031-301-0
Fax 07031-301-130
info@solo-germany.com

SOLO
P.O.Box 60 01 52
D 71050 Sindelfingen
Germany

Phone+49-7031-301-0
Fax +49-7031-301-149
export@solo-germany.com